

## FUNCTIONS OF VALVE POSITIONS

Valve Position	Function
FILTER	Normal Filtration and Vacuuming
BACKWASH	Cleaning Filter by reversing the flow
RINSE	Used after backwash to flush dirt from valve
WASTE	By-passes filter, used for vacuuming to waste or lowering water level
RECIRCULATE	By-passes filter for circulating water to pool
CLOSED	Shuts off all flow to filter or pool

### FILTER

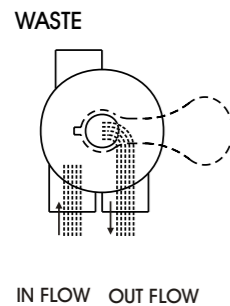

### WASTE

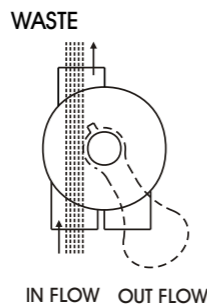

### CLOSED

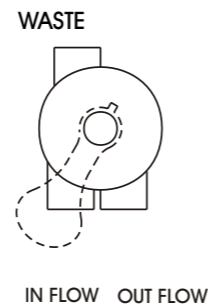

### BACKWASH

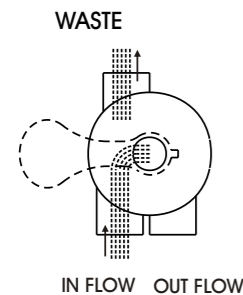

### RINSE

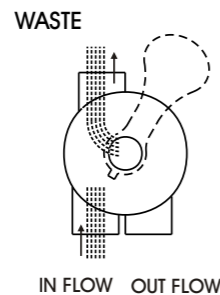

### RECIRCULATE

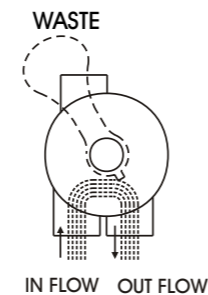

## GENERAL

1. Pipe tap boss provided for optional influent pressure gauge.
2. SERVICING VALVE( Stop pump,close gate valve in suction&discharge before proceeding):
  - a. Set handle in filter position.
  - b. Remove cover screws.
  - c. Lift cover and key assembly out.

## TO ASSEMBLE:

1. Place valve key so that wedge opening is at TOP port (handle in Filter psn.). Flat edge of cover screw lug should align with flat edge of body screw lug.
2. Position cover O'Ring.
3. Secure assembly to body with cover screws. Tighten cover screws evenly and alternately. Do not over-tighten.

## WARNING

- ⚠ THIS FILTER OPERATES UNDER HIGH PRESSURE. WHEN ANY PART OF THE CIRCULATING SYSTEM (e.g., CLAMP, PUMP, FILTER, VALVES, ETC.) IS SERVICED, AIR CAN ENTER THE SYSTEM AND BECOME PRESSURIZED. PRESSURIZED AIR CAN CAUSE THE LID OR VALVE TO BE BLOWN OFF WHICH CAN RESULT IN SEVERE INJURY, DEATH, OR PROPERTY DAMAGE
- ⚠ TURN PUMP OFF BEFORE CHANGING VALVE POSITION.
- ⚠ TO PREVENT DAMAGE TO THE PUMP AND FOR PROPER OPERATION OF THE SYSTEM, CLEAN PUMP STRAINER AND SKIMMER BASKETS REGULARLY.
- ⚠ DO NOT UNSCREW SCREWS OF FLANGE CLAMP WHILE PUMP IS RUNNING.

Models: S700B, S800,S900

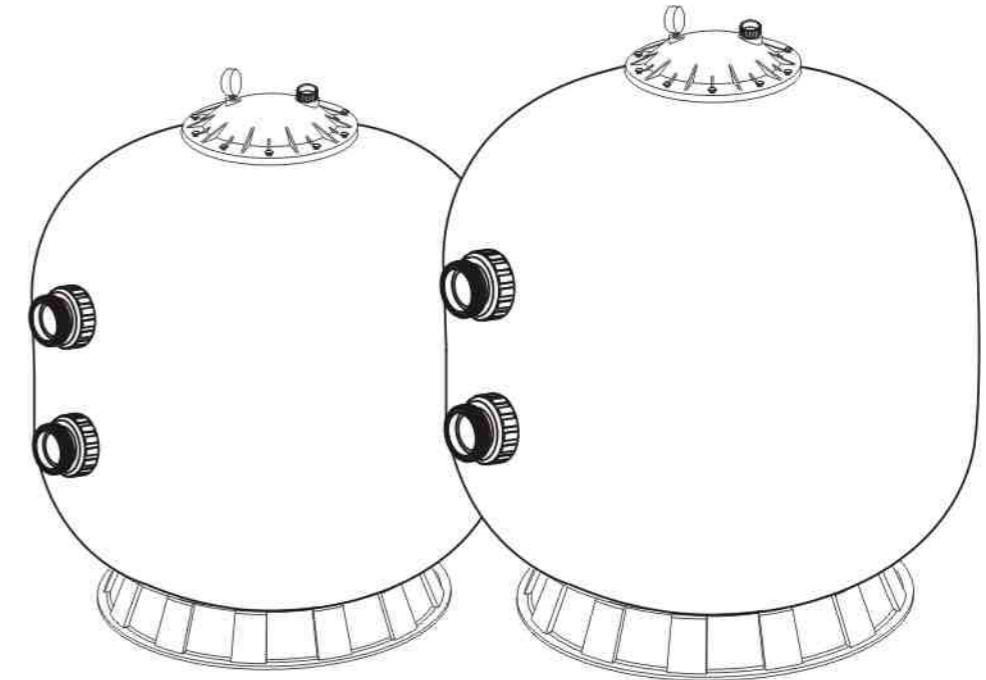

## FUNCTION

The filter uses special filter sand to remove dirt particles from pool water. The filter sand is loaded into the filter tank and functions as the permanent dirt removing media. When the control valve is in the FILTER position, the pool water which contains suspended dirt particles, is pumped through your piping system and is automatically directed by the patented filter control valve to the top of the filter tank. As the pool water is pumped through the filter, dirt particles are trapped by the sand bed, and filtered out. The cleaned Pool water is returned from the bottom of the filter tank, through the control valve and back to the pool through the piping system. This entire sequence is continuous and automatic and provides for total recirculation of pool water through your filter and piping System.

After a period of time the accumulated dirt in the filter causes a resistance to flow, and the flow diminishes. This means it is time to clean your filter. With the control valve in the BACKWASH position, the water flow is automatically reversed through the filter so that it is directed to the bottom of the tank, up through the sand, flushing the previously trapped dirt and debris out the waste line. Once the filter is back-washed of dirt, set control valve to RINSE position and run pump for about 1/2 to 1 minute, and then to filter, to resume normal filtering.

NOTE: Turn pump off before changing valve position.

## INSTALLATION

Only simple tools (screwdriver and wrenches), plus pipe sealant for plastic adapters, are required to install and service the filter.

1. The filter should be placed on a level concrete slab, very firm ground, or equivalent. Position the filter so that the piping connections, control valve are convenient and accessible for operation and service.
2. Loading the sand media. Filter sand media is loaded through the top opening of the filter.
  - a. Connect control valve to the filter using pipes with unions and glues.(see the fig on page4).
  - b. Loosen the twelve nuts and washers and remove the filter coping.
  - c. We recommend filling tank approximately 1/3 way with water to provide a cushion effect when the filter sand is poured in. This helps protect the under-drain laterals from excessive shock.
  - d. Carefully pour in correct amount and grade of filter sand. Sand surface should be leveled and should come to about the middle of the filter tank.

3. Replace filter coping. Put the twelve nuts and washers onto each of the twelve bolts, then screw all the nuts on with wrench, ensuring that all nuts are tight.
  - a. Carefully screw pressure gauge (with O'ring in place) into tapped hole in the filter coping. Do not over-tighten.
  - b. Ensure air relief valve (with O'ring in place) is tight fit to filter coping and turn it easily.
4. Connect pump to control valve opening marked PUMP.
5. Make return to pool pipe connection to control valve opening marked RETURN and complete other necessary plumbing connections, suction lines to pump, waste, etc.
6. Make electrical connections to pump per pump instructions.
7. To prevent water leakage, be sure all pipe connections are tight.

### MAIN DIMENSION

### DIMENSION TABLE

Model	High mm A	Diameter mm B	Valve Port Size Inch	Sand Kg
S700B	890	723	2"	215
S800	1050	820	2"	355
S900	1180	920	2"	470

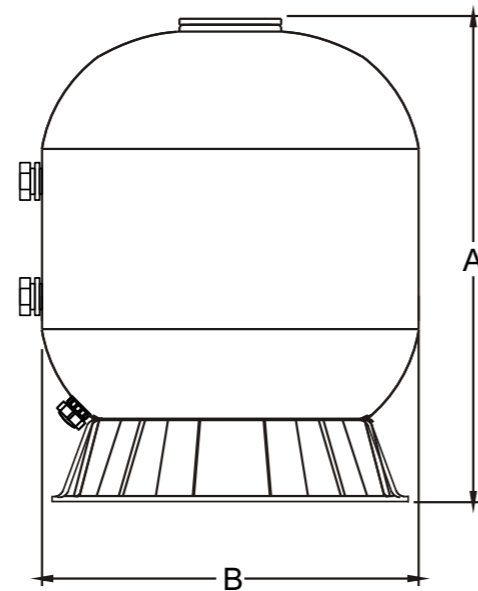

### INSTALL/START-UP OF FILTER

1. Be sure correct amount of filter media sand is in tank and that all connections have been made and are secure.
  2. Depress control valve handle and rotate to BACKWASH position. (To prevent damage to control valve seal, always depress handle before turning.)
  3. Prime and start pump according to pump instructions (be sure all suction and return lines are open), allowing the filter tank to fill with water. Once water is flowing out of the waste line, run the pump for at least 1 minute. The initial back-washing of the filter is recommended to remove any impurities or fine sand particles in the sand media.
  4. Turn pump off and set valve to RINSE position. Start pump and operate until water in sight glass is clear, about 1/2 to 1 minute. Turn pump off and set valve to FILTER position and restart pump. The filter is now operating in the normal filter mode, filtering dirt particles from the pool water.
  5. Adjust pool suction and return valves to achieve desired flow. Check system and filter for water leaks and tighten connections, bolts, nuts, as required.
  6. Note the initial pressure gauge reading when the filter is clean. (It will vary from pool to pool depending upon the pump and general piping system.) As the filter removes dirt and impurities from the pool water, the accumulation in the filter will cause the pressure to rise and flow to diminish. When the pressure gauge reading is 1.5 bar, higher than the initial "clean" pressure you noted, it is time to backwash the filter (see BACKWASH under filter and control valve functions).
- NOTE: During initial clean-up of the pool water it may be necessary to backwash frequently due to the unusually heavy initial dirt load in the water.

### REPLACEMENT PARTS OF FILTER

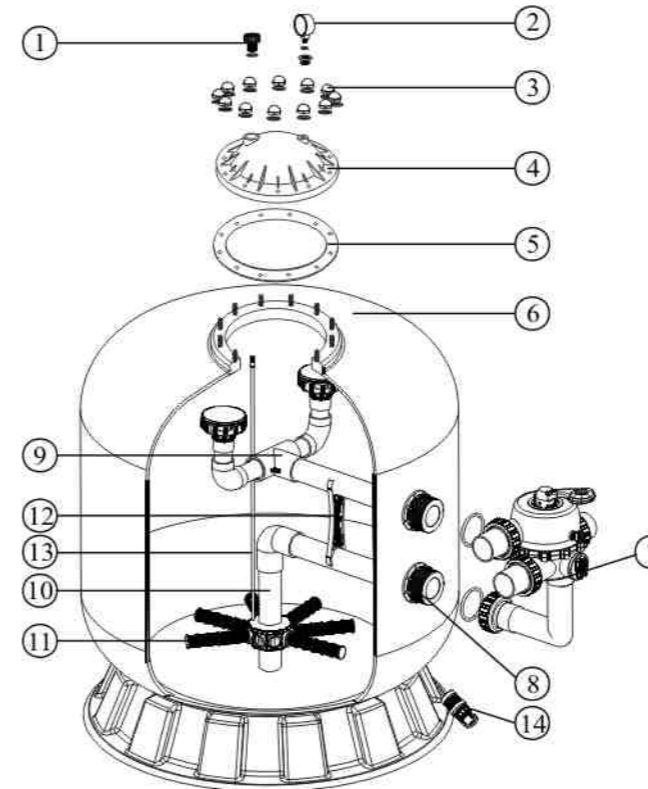

Item	Part No.	Description English	Qty
1	06011032	Oil Pressure Gauge With O-ring (40 psi)	1
	01111048	Connector for Pressure Gauge/Stopper	1
2	89010701	Air Release Valve	1
3	89010601	03013003 M8 Nut*12Pc; + 03012003 M8 Washer*12Pc;	1
4	01172005	Lid (Grey Colour)	1
5	02011126	Filter Neck Gasket	1
6	89011202	S700B Filter Tank With Base	1
	89011208	S800 Filter Tank With Base	1
	89011209	S900 Filter Tank With Base	1
7	88280806	2.0" Side Mount Valve	1
8	89011201	Connector Plate Side Mount	1
9	89011203	S700B Top part of the inner tank system	1
	89011210	S800 Top part of the inner tank system	1
	89011211	S900 Top part of the inner tank system	1
10	89011204	S700B Bottom part of the inner tank system	1
	89011212	S800 Bottom part of the inner tank system	1
	89011213	S900 Bottom part of the inner tank system	1
11	01172011	Laterals (233mm)	8
12	01111090	Tank System Support	1
13	89011205	S700B Air Vent Pipe	1
	89011206	S800 Air Vent Pipe	1
	89011207	S900 Air Vent Pipe	1
14	89010107	Water Drain Set	1

### REPLACEMENT PARTS OF MULTIPOINT VALVE

Item	Part No.	Description	Qty
1	01013003	Handle (Big)	1
2	03018008	Pin for Handle	1
3	01181027	Washer for Handle	1
4	01051026	2.0" Side Mount Valve Squareness Lid (White)	1
5	89280301	M6*32 Screw with Nut	10
6	01111048	Connector for Pressure Gauge/Stopper	1
7	89021703	Drain Plug with O'Ring	1
8	06011029	Oil Pressure Gauge With O-Ring (40Psi)	1
9	02011007	O-Ring for 2.0" Union	8
10	01051033	2.0" Connector (White)	3
11	01171154	2.0" Union (A/E)	3
12	01051032	2.0" Union Nut (White)	3
13	02011009	O-Ring for 2.0" Valve Lid	1
14	01181002	Washer for spring	1
15	02011022	O-Ring for 2.0" Valve Rotor	2
16	03014014	Spring	1
17	01021002	2.0" Valve Rotor	1
18	02311003	Spider Gasket	1
19	01051027	2.0" Side Mount Valve Bottom Body (White)	1
20	89280104	Sight Glass With O-Ring	1
21	02011011	O-Ring for Union Tale	1
22	01051035	2.0" Union Tale (White)	1
23	01051028	2.0" Union Nut (White)	2
24	02011010	O-Ring for Plug	1
25	01051029	2.0" Side Mount Valve Plug (White)	2
26	01051195	2.0" Elbow Tube (White) 183mm	1
27	01171035	2.0" Union Adaptor (Metric)	1

